

# NTHD4N02F

## Power MOSFET and Schottky Diode

20 V, 3.9 A, N-Channel, with 3.7 A Schottky Barrier Diode, ChipFET™

### Features

- Leadless SMD Package Featuring a MOSFET and Schottky Diode
- 40% Smaller than TSOP-6 Package with Better Thermals
- Super Low Gate Charge MOSFET
- Ultra Low  $V_F$  Schottky
- Pb-Free Package is Available

### Applications

- Fast Switching, low Gate Charge for Dc to Dc Buck and Boost Converters
- Li-Ion Battery Applications in Cell Phones, PDAs, DSCs, and Media Players
- Load Side Switching

### MOSFET MAXIMUM RATINGS ( $T_J = 25^\circ\text{C}$ unless otherwise noted)

Parameter		Symbol	Value	Unit
Drain-to-Source Voltage		$V_{DS}$	20	V
Gate-to-Source Voltage		$V_{GS}$	$\pm 12$	V
Continuous Drain Current	Steady State	$T_J = 25^\circ\text{C}$	$I_D$	2.9
				$T_J = 85^\circ\text{C}$
	$t \leq 5 \text{ s}$	$T_J = 25^\circ\text{C}$	3.9	
Pulsed Drain Current	$t_p = 10 \mu\text{s}$	$I_{DM}$	12	A
Power Dissipation	Steady State	$T_J = 25^\circ\text{C}$	$P_D$	0.91
				$T_J = 85^\circ\text{C}$
	$t \leq 5 \text{ s}$	$T_J = 25^\circ\text{C}$	2.1	
Continuous Source Current (Body Diode)		$I_S$	2.6	A
Operating Junction and Storage Temperature		$T_J, T_{STG}$	-55 to 150	$^\circ\text{C}$
Lead Temperature for Soldering Purposes (1/8" from case for 10 s)		$T_L$	260	$^\circ\text{C}$

### SCHOTTKY DIODE MAXIMUM RATINGS

( $T_J = 25^\circ\text{C}$  unless otherwise noted)

Parameter		Symbol	Value	Unit
Peak Repetitive Reverse Voltage		$V_{RRM}$	20	V
DC Blocking Voltage		$V_R$	20	V
Average Rectified Forward Current	Steady State	$T_J = 25^\circ\text{C}$	$I_F$	2.2
				$t \leq 5 \text{ s}$

Maximum ratings are those values beyond which device damage can occur. Maximum ratings applied to the device are individual stress limit values (not normal operating conditions) and are not valid simultaneously. If these limits are exceeded, device functional operation is not implied, damage may occur and reliability may be affected.



ON Semiconductor®

<http://onsemi.com>

### MOSFET

$V_{(BR)DSS}$	$R_{DS(on)}$ TYP	$I_D$ MAX
20 V	60 m $\Omega$ @ 4.5 V	3.9 A
	80 m $\Omega$ @ 2.5 V	

### SCHOTTKY DIODE

$V_R$ MAX	$V_F$ TYP	$I_F$ MAX
20 V	0.35 V	3.7 A

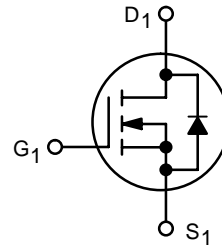

N-Channel MOSFET



SCHOTTKY DIODE

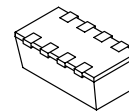

ChipFET™  
CASE 1206A  
STYLE 3

### PIN CONNECTIONS

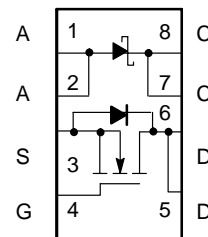

### MARKING DIAGRAM

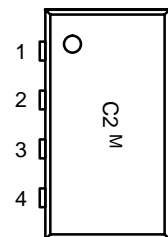

C2 = Specific Device Code  
M = Month Code

### ORDERING INFORMATION

Device	Package	Shipping†
NTHD4N02FT1	ChipFET	3000/Tape & Reel
NTHD4N02FT1G	ChipFET (Pb-Free)	3000/Tape & Reel

†For information on tape and reel specifications, including part orientation and tape sizes, please refer to our Tape and Reel Packaging Specifications Brochure, BRD8011/D.

# NTHD4N02F

## THERMAL RESISTANCE RATINGS

Parameter	Symbol	Max	Unit
Junction-to-Ambient – Steady State (Note 1)	$R_{\theta JA}$	110	$^{\circ}\text{C/W}$
Junction-to-Ambient – $t \leq 5$ s	$R_{\theta JA}$	60	$^{\circ}\text{C/W}$

1. Surface Mounted on FR4 Board using 1 in sq. pad size (Cu area = 1.27 in sq. [1 oz] including traces).

## MOSFET ELECTRICAL CHARACTERISTICS ( $T_J = 25^{\circ}\text{C}$ unless otherwise noted)

Parameter	Symbol	Test Conditions	Min	Typ	Max	Units
-----------	--------	-----------------	-----	-----	-----	-------

### OFF CHARACTERISTICS

Drain-to-Source Breakdown Voltage	$V_{(BR)DSS}$	$V_{GS} = 0$ V, $I_D = 250$ $\mu\text{A}$	20	28		V
Zero Gate Voltage Drain Current	$I_{DSS}$	$V_{GS} = 0$ V $V_{DS} = 16$ V	$T_J = 25^{\circ}\text{C}$		1.0	$\mu\text{A}$
			$T_J = 85^{\circ}\text{C}$		5.0	
Gate-to-Source Leakage Current	$I_{GSS}$	$V_{DS} = 0$ V, $V_{GS} = \pm 12$ V			$\pm 100$	nA

### ON CHARACTERISTICS (Note 2)

Gate Threshold Voltage	$V_{GS(TH)}$	$V_{GS} = V_{DS}$ , $I_D = 250$ $\mu\text{A}$	0.6		1.2	V
Drain-to-Source On-Resistance	$R_{DS(on)}$	$V_{GS} = 4.5$ , $I_D = 2.9$ A		0.058	0.080	$\Omega$
		$V_{GS} = 2.5$ , $I_D = 2.3$ A		0.077	0.115	
Forward Transconductance	$g_{FS}$	$V_{DS} = 10$ V, $I_D = 2.9$ A		6.0		S

### CHARGES AND CAPACITANCES

Input Capacitance	$C_{ISS}$	$V_{GS} = 0$ V, $f = 1.0$ MHz, $V_{DS} = 10$ V		180	300	pF
Output Capacitance	$C_{OSS}$			80	130	
Reverse Transfer Capacitance	$C_{RSS}$			30	50	
Total Gate Charge	$Q_{G(TOT)}$	$V_{GS} = 4.5$ V, $V_{DS} = 10$ V, $I_D = 2.9$ A		2.6	4.0	nC
Gate-to-Source Charge	$Q_{GS}$			0.6		
Gate-to-Drain Charge	$Q_{GD}$			0.7		

### SWITCHING CHARACTERISTICS (Note 3)

Turn-On Delay Time	$t_{d(ON)}$	$V_{GS} = 4.5$ V, $V_{DD} = 16$ V, $I_D = 2.9$ A, $R_G = 2.5$ $\Omega$		5.0	10	ns
Rise Time	$t_r$			9.0	18	
Turn-Off Delay Time	$t_{d(OFF)}$			10	20	
Fall Time	$t_f$			3.0	6.0	

### DRAIN-SOURCE DIODE CHARACTERISTICS (Note 2)

Forward Diode Voltage	$V_{SD}$	$V_{GS} = 0$ V, $I_S = 2.6$ A		0.8	1.15	V
Reverse Recovery Time	$t_{RR}$	$V_{GS} = 0$ V, $I_S = 2.6$ A, $di_S/dt = 100$ A/ $\mu\text{s}$		12.5		ns
Charge Time	$t_a$			9.0		
Discharge Time	$t_b$			3.5		
Reverse Recovery Charge	$Q_{RR}$			6.0		

### SCHOTTKY DIODE ELECTRICAL CHARACTERISTICS ( $T_J = 25^{\circ}\text{C}$ unless otherwise noted)

Parameter	Symbol	Test Conditions	Min	Typ	Max	Units
Maximum Instantaneous Forward Voltage	$V_F$	$I_F = 0.1$ A			0.31	V
		$I_F = 1.0$ A			0.365	
Maximum Instantaneous Reverse Current	$I_R$	$V_R = 10$ V			0.75	mA
		$V_R = 20$ V			2.5	
Non-Repetitive Peak Surge Current	$I_{FSM}$	Halfwave, Single Pulse, 60 Hz			23	A

2. Pulse Test: Pulse Width  $\leq 300$   $\mu\text{s}$ , Duty Cycle  $\leq 2\%$ .  
3. Switching characteristics are independent of operating junction temperatures.

# NTHD4N02F

## TYPICAL MOSFET PERFORMANCE CURVES ( $T_J = 25^\circ\text{C}$ unless otherwise noted)

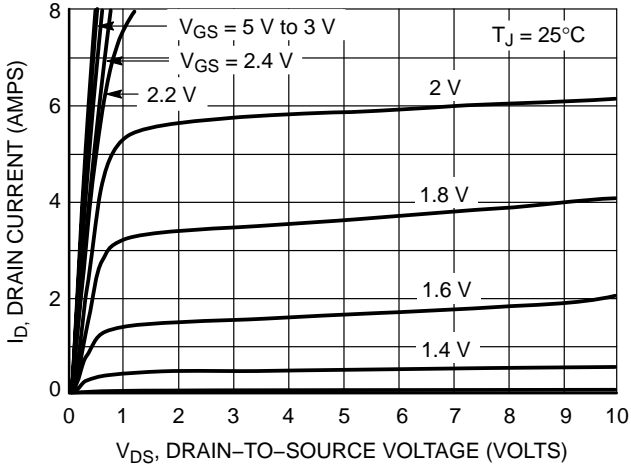

**Figure 1. On-Region Characteristics**

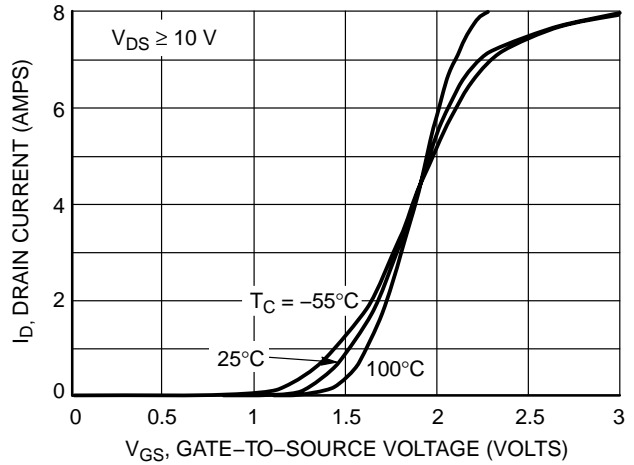

**Figure 2. Transfer Characteristics**

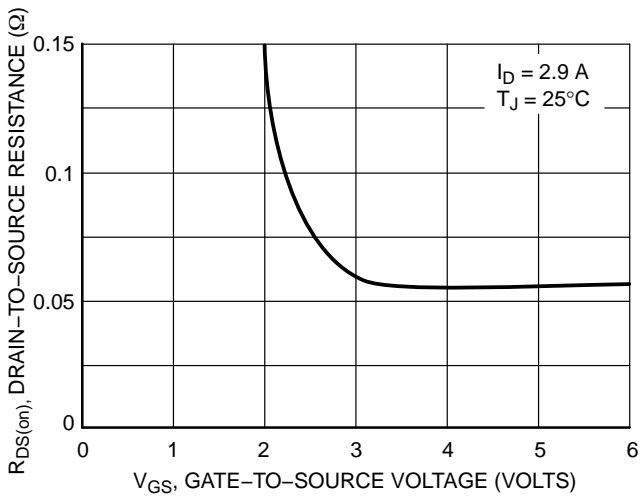

**Figure 3. On-Resistance vs. Gate-to-Source Voltage**

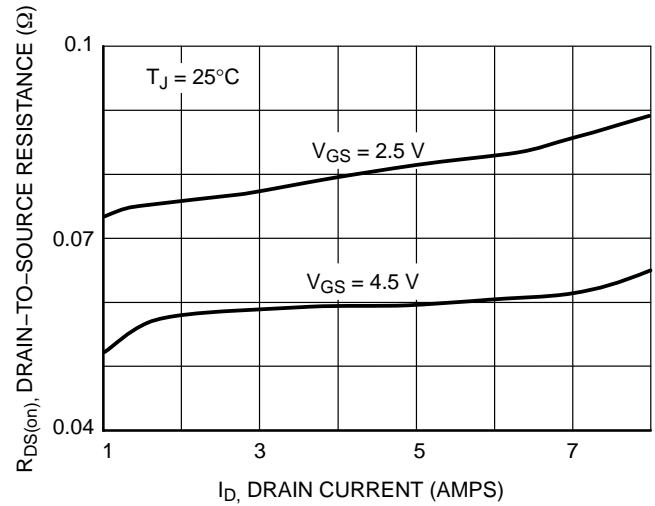

**Figure 4. On-Resistance vs. Drain Current and Gate Voltage**

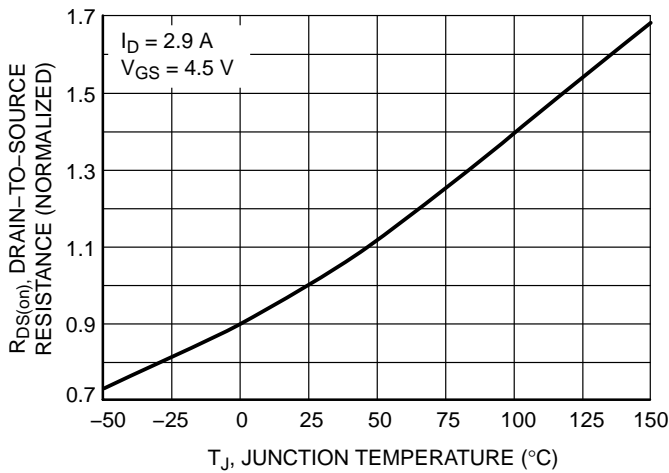

**Figure 5. On-Resistance Variation with Temperature**

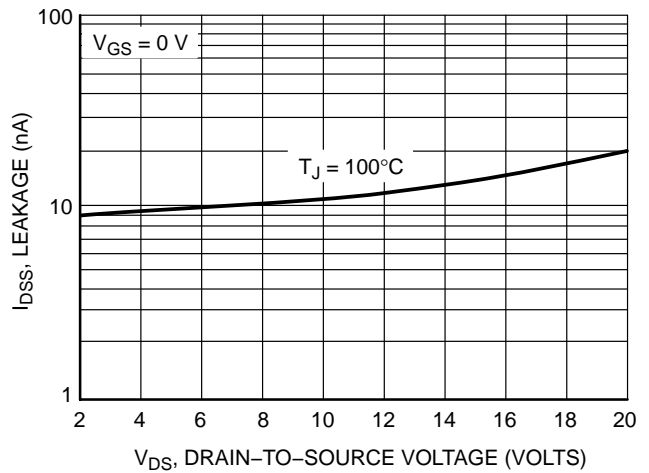

**Figure 6. Drain-to-Source Leakage Current vs. Voltage**

# NTHD4N02F

## TYPICAL MOSFET PERFORMANCE CURVES (T<sub>J</sub> = 25°C unless otherwise noted)

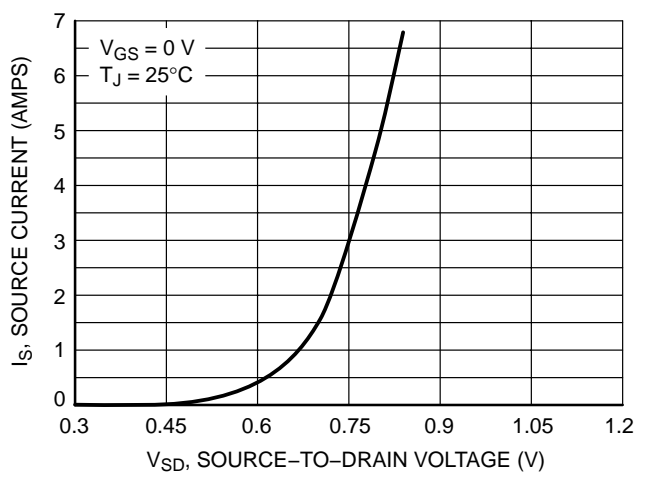
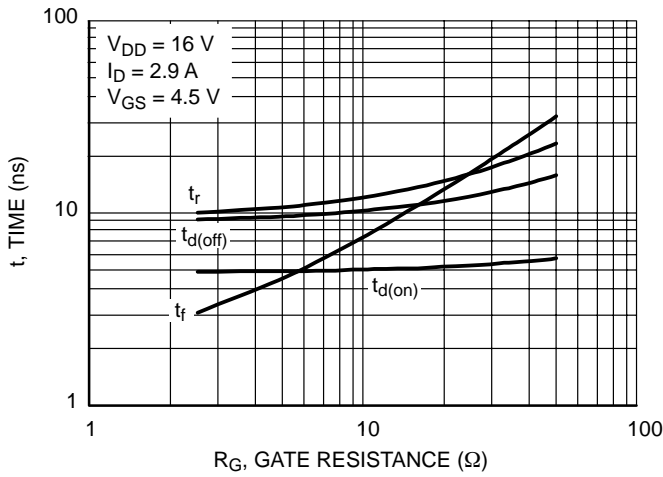
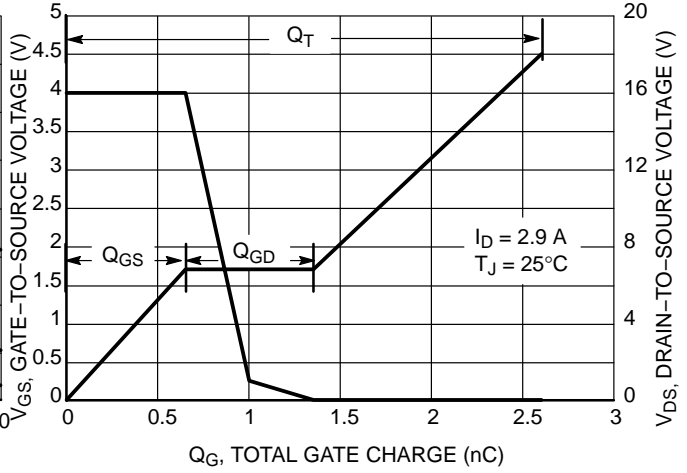
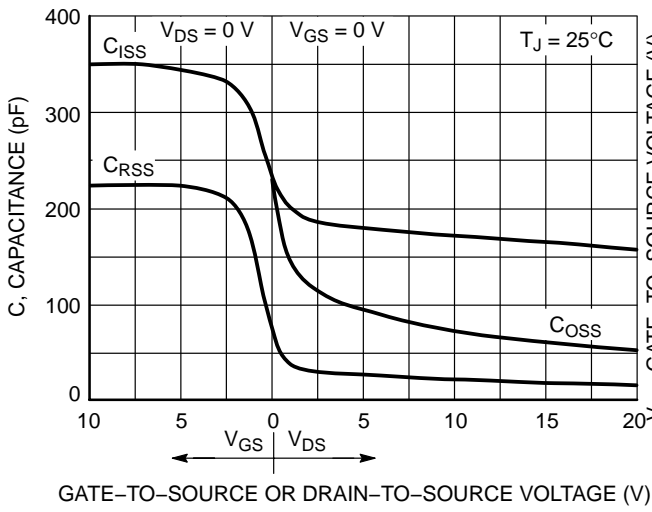

# NTHD4N02F

## TYPICAL SCHOTTKY PERFORMANCE CURVES ( $T_J = 25^\circ\text{C}$ unless otherwise noted)

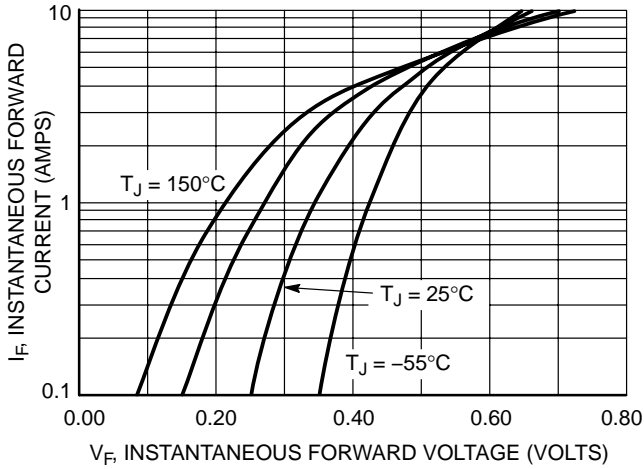

Figure 11. Typical Forward Voltage

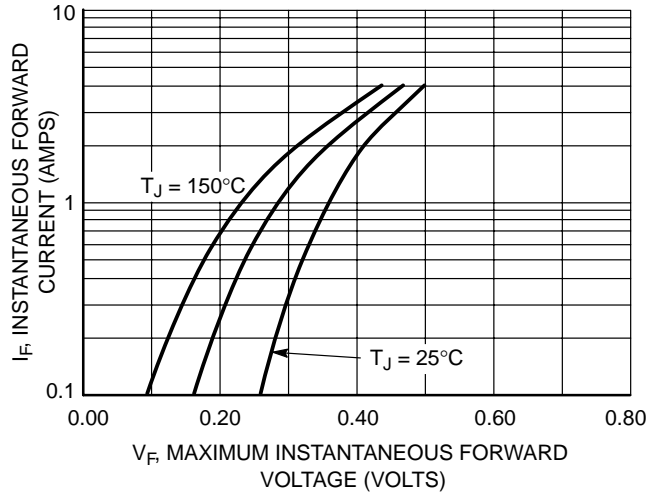

Figure 12. Maximum Forward Voltage

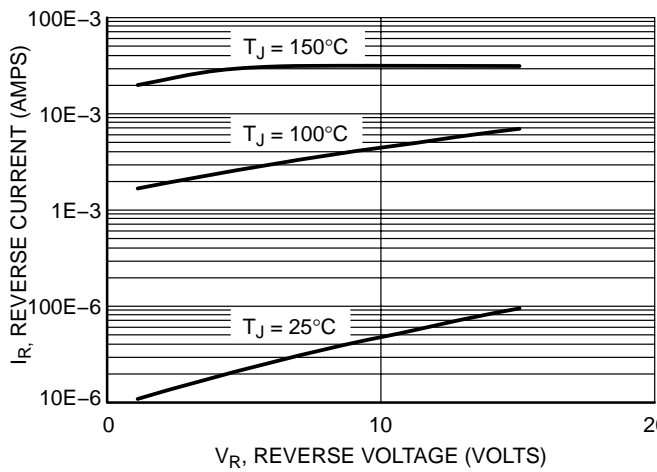

Figure 13. Typical Reverse Current

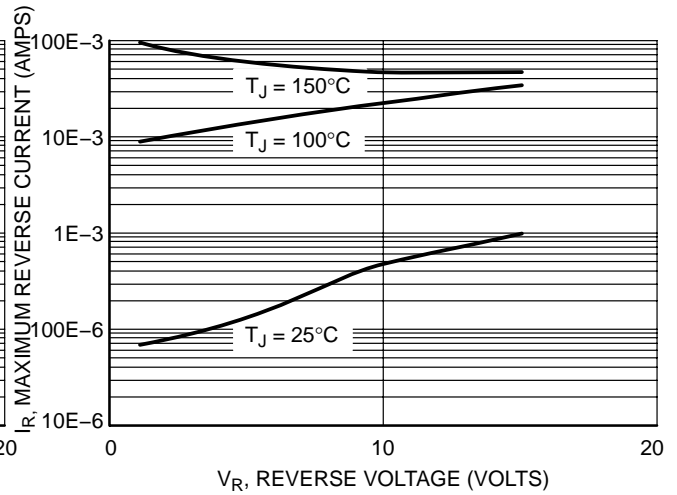

Figure 14. Maximum Reverse Current

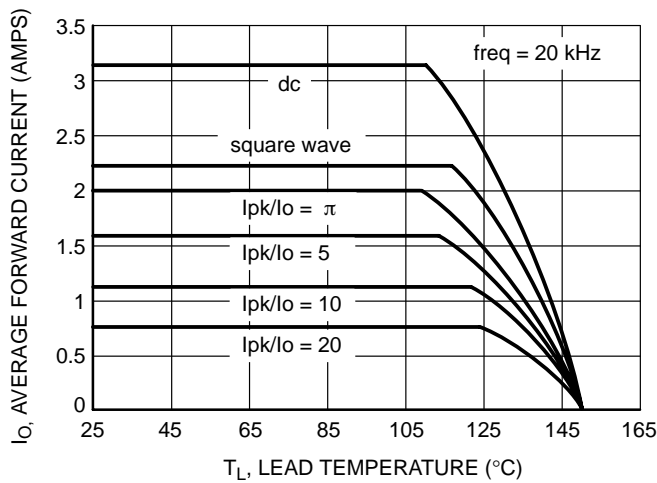

Figure 15. Current Derating

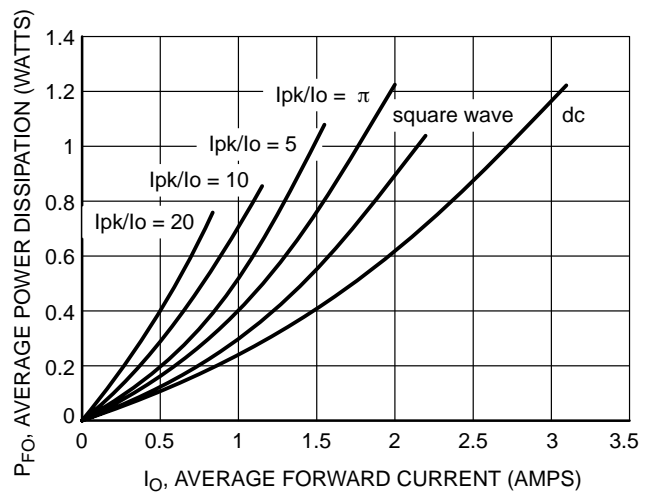
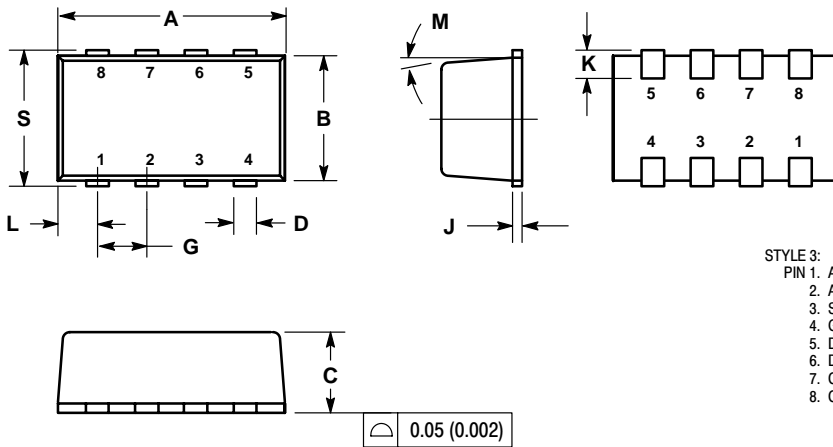

Figure 16. Forward Power Dissipation

# NTHD4N02F

## PACKAGE DIMENSIONS

ChipFET  
CASE 1206A-03  
ISSUE E



**NOTES:**

1. DIMENSIONING AND TOLERANCING PER ANSI Y14.5M, 1982.
2. CONTROLLING DIMENSION: MILLIMETER.
3. MOLD GATE BURRS SHALL NOT EXCEED 0.13 MM PER SIDE.
4. LEADFRAME TO MOLDED BODY OFFSET IN HORIZONTAL AND VERTICAL SHALL NOT EXCEED 0.08 MM.
5. DIMENSIONS A AND B EXCLUSIVE OF MOLD GATE BURRS.
6. NO MOLD FLASH ALLOWED ON THE TOP AND BOTTOM LEAD SURFACE.
7. 1206A-01 AND 1206A-02 OBSOLETE. NEW STANDARD IS 1206A-03.

STYLE 3:  
PIN 1. A  
2. A  
3. S  
4. G  
5. D  
6. D  
7. C  
8. C

DIM	MILLIMETERS		INCHES	
	MIN	MAX	MIN	MAX
A	2.95	3.10	0.116	0.122
B	1.55	1.70	0.061	0.067
C	1.00	1.10	0.039	0.043
D	0.25	0.35	0.010	0.014
G	0.65 BSC		0.025 BSC	
J	0.10	0.20	0.004	0.008
K	0.28	0.42	0.011	0.017
L	0.55 BSC		0.022 BSC	
M	5° NOM		5° NOM	
S	1.80	2.00	0.072	0.080

## SOLDER FOOTPRINTS\*

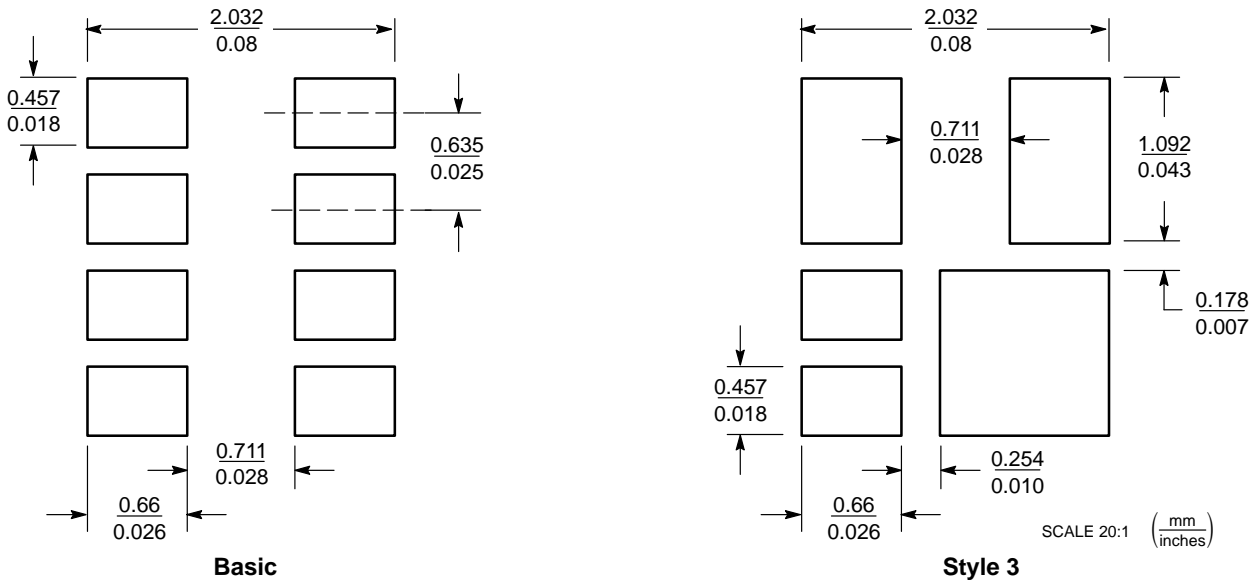

\*For additional information on our Pb-Free strategy and soldering details, please download the ON Semiconductor Soldering and Mounting Techniques Reference Manual, SOLDERRM/D.

ChipFET is a trademark of Vishay Siliconix.

ON Semiconductor and are registered trademarks of Semiconductor Components Industries, LLC (SCILLC). SCILLC reserves the right to make changes without further notice to any products herein. SCILLC makes no warranty, representation or guarantee regarding the suitability of its products for any particular purpose, nor does SCILLC assume any liability arising out of the application or use of any product or circuit, and specifically disclaims any and all liability, including without limitation special, consequential or incidental damages. "Typical" parameters which may be provided in SCILLC data sheets and/or specifications can and do vary in different applications and actual performance may vary over time. All operating parameters, including "Typicals" must be validated for each customer application by customer's technical experts. SCILLC does not convey any license under its patent rights nor the rights of others. SCILLC products are not designed, intended, or authorized for use as components in systems intended for surgical implant into the body, or other applications intended to support or sustain life, or for any other application in which the failure of the SCILLC product could create a situation where personal injury or death may occur. Should Buyer purchase or use SCILLC products for any such unintended or unauthorized application, Buyer shall indemnify and hold SCILLC and its officers, employees, subsidiaries, affiliates, and distributors harmless against all claims, costs, damages, and expenses, and reasonable attorney fees arising out of, directly or indirectly, any claim of personal injury or death associated with such unintended or unauthorized use, even if such claim alleges that SCILLC was negligent regarding the design or manufacture of the part. SCILLC is an Equal Opportunity/Affirmative Action Employer. This literature is subject to all applicable copyright laws and is not for resale in any manner.

## PUBLICATION ORDERING INFORMATION

**LITERATURE FULFILLMENT:**  
Literature Distribution Center for ON Semiconductor  
P.O. Box 61312, Phoenix, Arizona 85082-1312 USA  
**Phone:** 480-829-7710 or 800-344-3860 Toll Free USA/Canada  
**Fax:** 480-829-7709 or 800-344-3867 Toll Free USA/Canada  
**Email:** orderlit@onsemi.com

**N. American Technical Support:** 800-282-9855 Toll Free  
USA/Canada

**Japan:** ON Semiconductor, Japan Customer Focus Center  
2-9-1 Kamimeguro, Meguro-ku, Tokyo, Japan 153-0051  
**Phone:** 81-3-5773-3850

**ON Semiconductor Website:** <http://onsemi.com>

**Order Literature:** <http://www.onsemi.com/litorder>

For additional information, please contact your local Sales Representative.